

# K 940 S x-motion



## The top model for highest demands

The special model with innovative operating elements, intelligent detail solutions and maximum user-friendliness. The large dimensioned saw unit allows large blade diameters and maximum power transfer at all three speeds. The CNC control via 5.7" (145 mm) colour touch screen in the overhead control panel offers professional

productivity: positioning control for saw blade height and angle, automatic cutting height correction during tilting, display for circular saw blade speed, control for continuous adjustable saw blade speed (optional), positioning control for rip fence with automatic dimension correction when saw blade is tilted (optional).

## Panel saws 900 SERIES

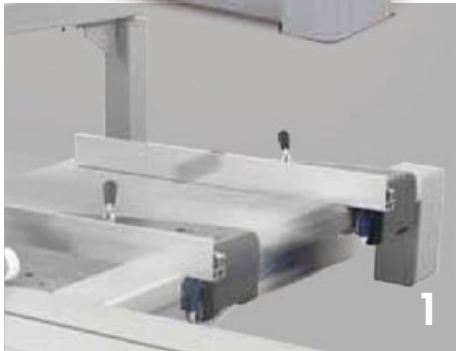

1



3



4

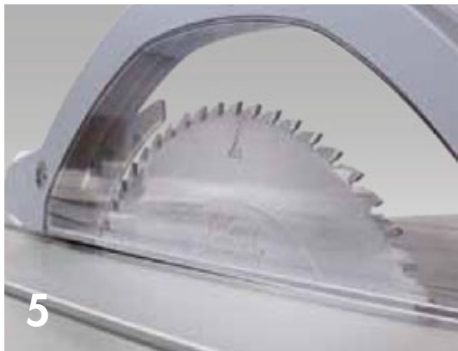

5



2

- 1 Rip fence with positioning control
- 2 The standard LCD screen control with touch function
- 3 Saw blade change without tools
- 4 "X-Roll" format sliding table
- 5 Cutting height 133 mm, 3 rotation speeds (3500/4500/5500 rpm)



6

 FELDER  
Quality and precision  
in a nutshell

- 6 Automatic scoring unit

## Tilt segment "Easy-Glide"



only by  
**FELDER**

The patented tilt segment "Easy-Glide" used in the Felder 700 and 900 series saw and spindle moulder aggregates and also Format-4, fulfils the highest requirements in business and industry. A precise, guided, double-sided support, guarantees maximum load bearing and tolerance free tilting and is absolutely maintenance free. A special, highly durable synthetic material situated in the guide of the tilting segment ensures extremely smooth movement and long-lasting precision. The tilting guide system, a synthetic material tried and tested in aerospace and lock construction, works without the requirement of lubrication and is totally resistant to dust. With a 6 year factory guarantee, this Felder component offers reliability for many years to come.

EASY-GLIDE

**6** YEAR  
GUARANTEE

**This is why:**

- > Precise, double sided guide support
- > Maximum load bearing capacity
- > Play-free tilt
- > Unaffected by dust
- > Completely maintenance free
- > Completely lubrication free

# Panel Saws

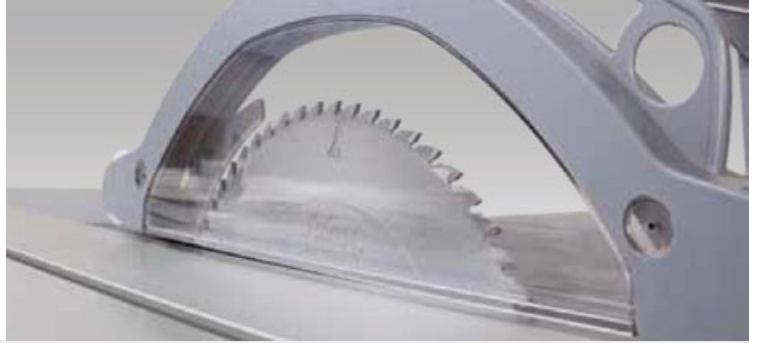

## The FELDER "133" saw unit

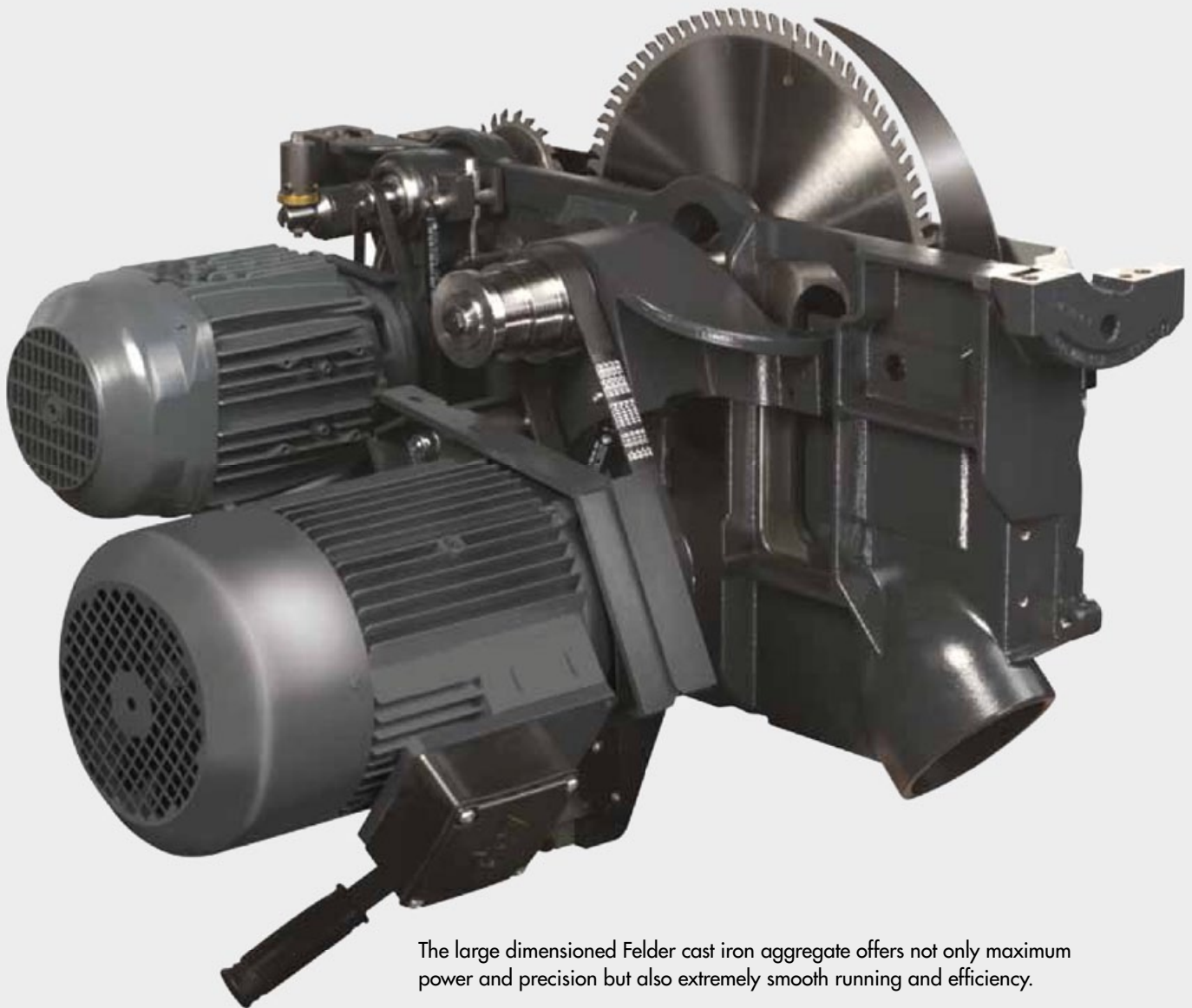

The large dimensioned Felder cast iron aggregate offers not only maximum power and precision but also extremely smooth running and efficiency.

- > Single cast aggregate made from solid cast iron without welding joints. Stability and safety are considerably increased as a result
- > 133 mm cutting height with a 400 mm saw blade diameter
- > Electrical height adjustment
- > Optional: Electronic angle adjustment with digital LED display
- > Dovetail guidance system of the height adjustment
- > Maximum power transmission achieved through the POLY-V belts and counter surface
- > 3 speeds: 3,500/4,500/5,500 rpm
- > Optimal extraction with a completely enclosed saw aggregate and below table extraction system
- > Large dimensioned, double ball bearing saw arbour



# Panel Saws

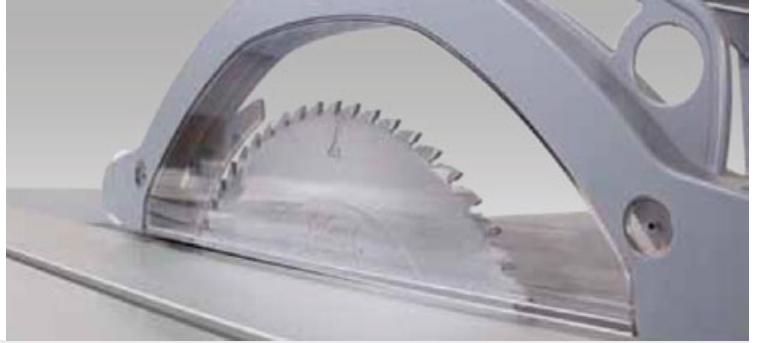

Panel saw control with an accuracy of a tenth of a millimetre  
Top class FELDER operating comfort



## K 940 S x-motion, up to 5 positionable axes

CNC-drive control unit with 5.7" LCD colour screen (145 mm) positioned in the overhead control panel

- > Automatic cutting depth compensation when tilting
- > Saw speed display
- > Positioning control of the rip fence with automatic measurement correction when the saw blade is at an angle (option)
- > All functions can also be adjusted in touch control mode
- > 99 memory positions in the tooling database

Up to 5 positionable axes

- > Saw blade height control
- > Saw blade tilt control
- > Positioning control of the rip fence
- > 9x 99 cutting program, incremental measurement function
- > 2 axes scoring unit as an option



## Constant repeat accuracy with "Power-Drive" K2

The fully electrical "Power-Drive" K2 control offers exact adjustment and repeat accuracy. The saw blade height and the angle settings can be adjusted at the turn of a knob, the fine setting adjustments are carried out to tenth of a millimetre accuracy using a push button. An LED display screen shows the actual current value in real time directly on the control panel.



## Comfortable precision with "Power-Drive" K1

Push-button height adjustment, precise to a tenth of a millimetre. Manual saw blade tilt adjustment also available as an option with a dial display for maximum precision.



Your Felder, as individual as you!

Machine equipment options	K 500	K 500 Professional	K 500 S	K 540 S	K 700	K 700 Professional	K 700 S	K 740	K 740 Professional	K 740 S	K 940 S
Handwheel	S	S	S	S	S	S	S	S	S	S	-
"Power-Drive" K1	-	-	-	-	O	O	O	O	O	O	S
"Power-Drive" K2	-	-	-	-	O	O	O	O	O	O	O

S ... Standard features    O ... Option    - ... not available

“Easy-Lock” tool free saw blade change  
Unique worldwide

only by  
**FELDER**



Change your saw blades safely and without any tools in record time: the maintenance-free “Easy-Lock” quick-change saw blade system offers unique user comfort that is unmatched worldwide!

The patented power transfer system creates the required pressure on the flange. The clamping system is maintenance free and offers premium comfort for many years: Change saw blades effortlessly in literally no time at all. No more searching for tools, no worn-out clamping screws or injury caused by the blade slipping whilst changing – complete workplace safety and maximum productivity are guaranteed with “Easy-lock”.

**Simple, safe & quick – “Quick-lock” saw blade clamping**

An alternative to the worldwide unique Felder saw blade quick change system “Easy-lock”, there is now the “Quick-lock” clamping system, which with the use of just one tool ensures quick and easy exchange of the saw blade.



Machine equipment options	K 500	K 500 Professional	K 500 S	K 540 S	K 700	K 700 Professional	K 700 S	K 740	K 740 Professional	K 740 S	K 940 S
“Easy-Lock” saw blade quick change system	-	-	-	-	-	-	-	-	-	-	○
Saw blade clamping “Quick-Lock”	-	-	-	-	-	-	-	-	-	-	○

S ... Standard features ○ ... Option - ... not available



Your Felder, as individual as you!

# Panel Saws

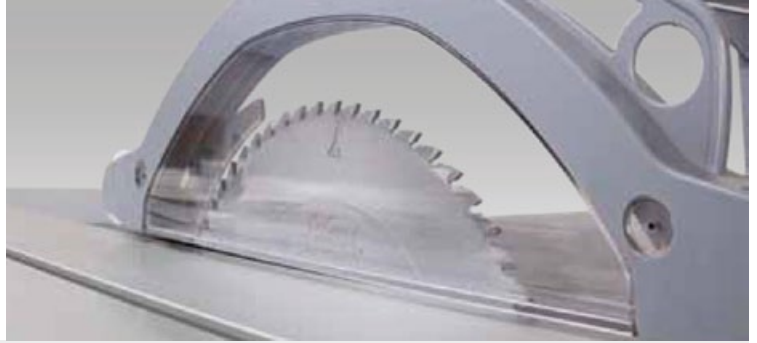

## FELDER scoring unit



### Scoring unit

For chip free cuts in laminated panels. The saw blade can be mechanically or electrically driven and can be adjusted in both height and lateral position.

Classic: With an additional motor, the electrically driven scoring saw can be switched on independently from the main blade. The vertical and lateral adjustment of the scoring saw blade is carried out manually.

Automatic K 940 S: The height adjustment of the motor driven scoring blade can be done electrically at the turn of a knob, whereas the lateral settings are done manually. Once the scoring blade starts, it moves automatically to its previously set vertical position and moves back completely under the saw table when switched off. Top of the range comfort!

### Safety made visible - Scoring unit operation display

As of now, a red LED strip signals the operation of the scoring unit, offering even more working safety. (Option)

Scoring unit with 2 controlled axes: The scoring unit blade height and lateral position relating to the saw blade can be positioned with ease using the control panel. The scoring blade data can be saved in the database specific to a certain saw blade. Next time the saw blade is used, the scoring blades moves automatically into position.

Machine equipment options	K 500	K 500 Professional	K 500 S	K 540 S	K 700	K 700 Professional	K 700 S	K 740	K 740 Professional	K 740 S	K 940 S
Scoring unit	○	○	○	○	○	○	○	○	○	○	○
Automatic scoring unit	-	-	-	-	-	-	-	-	-	-	○
Scoring unit operation display	-	-	-	-	-	-	-	-	-	-	○
2 axes scoring unit	-	-	-	-	-	-	-	-	-	-	○

S ... Standard features ○ ... Option - ... not available

## FELDER Format Sliding Table

Unrivalled smoothness and precision

only by  
**FELDER**

X-ROLL  
**10** YEAR  
GUARANTEE

### **The stability:**

Completely torsion resistant due to the solid profile construction.

### **Masterpiece sliding table.**

#### **Unrivalled precision and smooth running!**

Large dimensioned and designed with high use in mind, the aluminium format sliding table "hovers" on the "X-Roll", a highly developed guiding technology for Felder sliding tables. The X shape ("X-Roll") design of the rollers distributes the load optimally on all sides. The linear surface of the steel rollers running on the hardened and ground guiding surface guarantees unbeatable precision and smoothness. "X-Roll" will guarantee you the quality and precision that you expect from your new panel saw. Another reason to choose Felder: Ten year factory guarantee to underline the reliability of "X-Roll".



Your Felder, as  
individual as you!



# Panel Saws

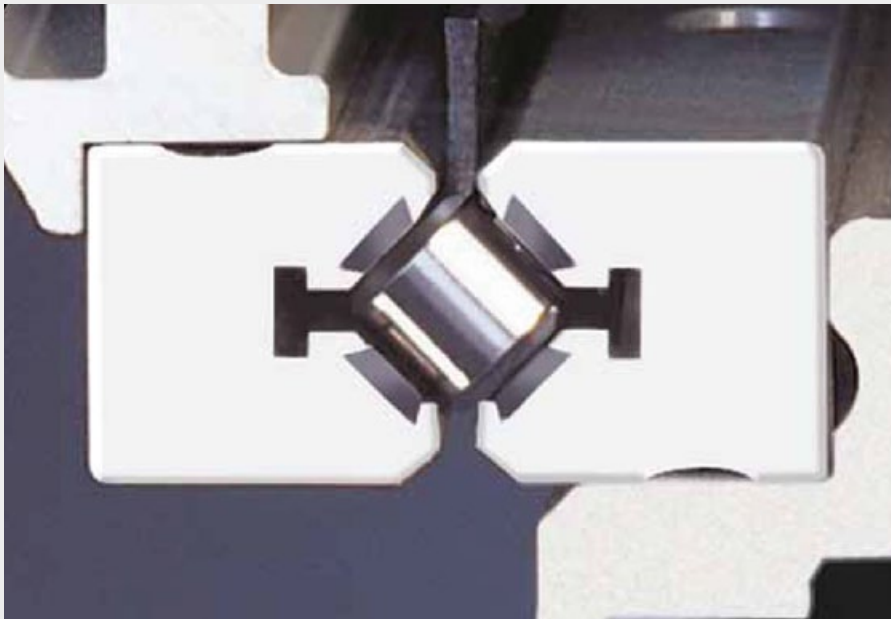

## The durability:

Long lasting table guides with Felder linear guidance system: No single point contact with roller bearings.

## This is why:

- Extremely smooth, durable guiding system. The roller bearings have no single point of contact
- Dust resistant construction of the guiding system, ensuring dust free and clean guides
- Hardened and ground guide tracks

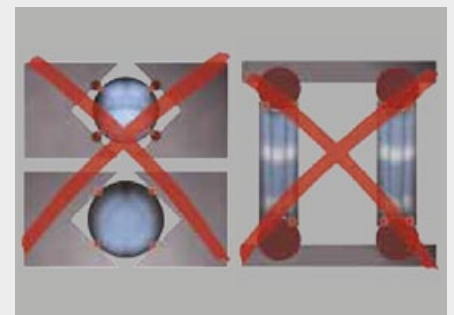

## Protected from contamination:

Dust protection due to the special "12-fold" wiper system

- > 4 wiping brushes
- > 8 silicone wipers

## Maintenance-free:

Maintenance free and protected from dust due to the covered guides facing inwards.

Other guiding systems with single contact points.

Machine equipment options	K 500	K 500 Professional	K 500 S	K 540 S	K 700	K 700 Professional	K 700 S	K 740	K 740 Professional	K 740 S	K 940 S
Format sliding table, 1300 mm* <sup>1)</sup>	S	-	-	-	S	-	-	S	-	-	-
Format sliding table, 1550 mm*	O	-	-	-	O	-	-	O	-	-	-
Format sliding table, 2050 mm* <sup>1)</sup>	O	S	-	-	O	S	-	O	S	-	O
Format sliding table, 2500 mm*	O	O	S	-	O	O	S	O	O	S	S
Format sliding table, 2800 mm* <sup>1)</sup>	-	-	O	-	-	-	O	-	-	O	O
Format sliding table, 3200 mm* <sup>1)</sup>	-	-	O	-	-	-	O	-	-	O	O
Format sliding table, 3700 mm*	-	-	-	-	-	-	O	-	-	-	O
Remote ON switch on sliding table	-	-	-	-	O	O	O	O	O	O	O

S ... Standard configuration O ... Option - ... not available

\* ... Cutting length with outrigger table at maximum cutting height <sup>1)</sup> ... Format sliding table hand grip as standard

## Sliding table handle grip as standard

On demand, you can increase user-friendliness and shorten working distances with the ON and OFF buttons directly on the Format sliding table.



### Sliding table handle grip for

- > Cutting length 1550 mm
- > Cutting length 2500 mm
- > Cutting length 3700 mm



Your Felder, as individual as you!

# Panel Saws

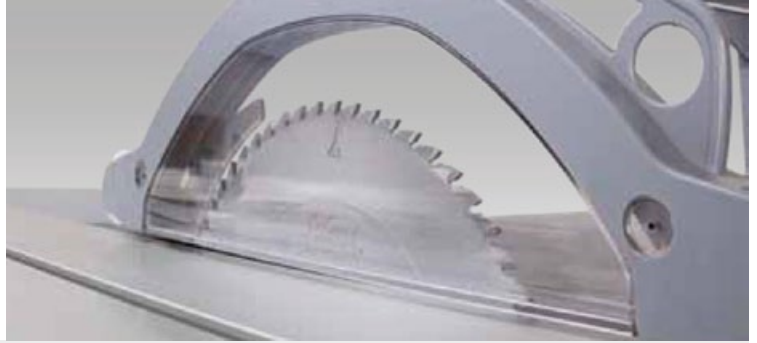

## The new FELDER overhead saw guard Pure flexibility

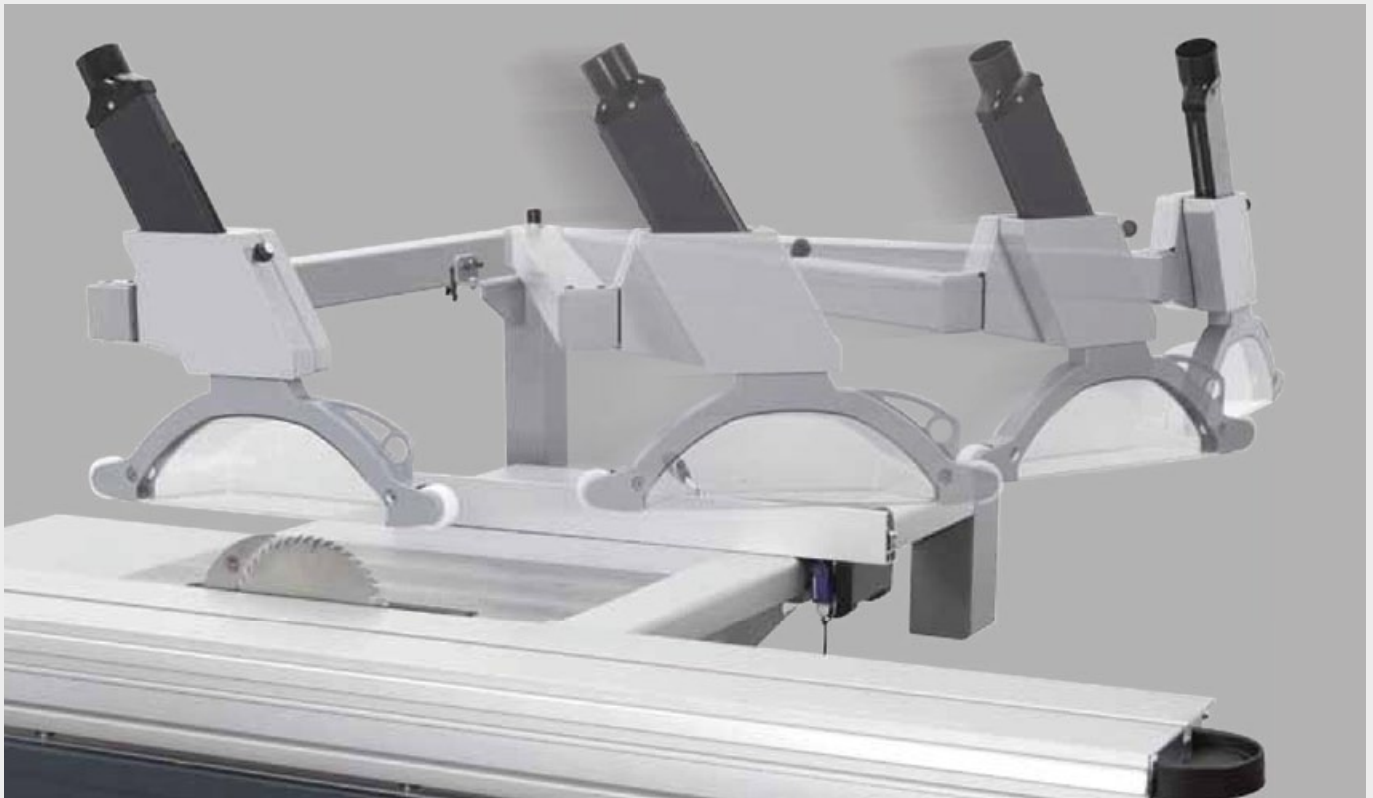

Highest operating safety and maximum flexibility when processing large dimensioned workpieces: the new Felder overhead saw guard can be swung away easily and is always there for when it is required.



### Even more space: Optimised extraction pipe connection

The optimised extraction pipe guide guarantees that there is always enough space and a clean working surface.

Machine equipment options	K 500	K 500 Professional	K 500 S	K 540 S	K 700	K 700 Professional	K 700 S	K 740	K 740 Professional	K 740 S	K 940 S
Extraction pipe connection	<input type="radio"/>	<input type="radio"/>	<input type="radio"/>	-	<input type="radio"/>	<input type="radio"/>	<input type="radio"/>	-	-	-	-
Overhead saw guard	<input type="radio"/>	<input type="radio"/>	<input type="radio"/>	S	<input type="radio"/>	<input type="radio"/>	<input type="radio"/>	S	S	S	S

S... Standard features     ... Option    -... not available

## Outrigger table For every challenge



### 1300 and 1500 outrigger tables

The workpiece roller at the end of the outrigger guarantees the smooth loading of workpieces (from 700 series).

The telescopic fence can be moved to any position between 90° and 45°. For those that require even more support surface, the 1500 outrigger is available instead of the 1300 outrigger at no additional cost.

### The 1100 outrigger table

(Standard on professional models)

The outrigger table makes it much easier to process large and heavy workpieces when using the sliding table. There are four ball bearing guide rollers in the outrigger telescopic arm for maximum precision and smoothness.

Machine equipment options	K 500	K 500 Professional	K 500 S	K 540 S	K 700	K 700 Professional	K 700 S	K 740	K 740 Professional	K 740 S	K 940 S
1100 outrigger table	O	S	-	-	O	S	-	O	S	-	-
1300 outrigger table	O	O	S	S	-	-	-	-	-	-	-
Outrigger table 1300 with workpiece roller	-	-	-	-	O	O	S	O	O	S	S
Outrigger table 1500 with workpiece roller	-	-	-	-	-	-	W	-	-	W	W

S ... Standard features   O ... Option   - ... not available   W ... Option available without a surcharge



# Panel Saws



## Outrigger crosscut fence

Precise cross and mitre cutting

The outrigger crosscut fence with its adjustable length of up to 2600 mm can be moved to any position between 90° and 45°. If required, a mitre index system with locking points at 5° intervals is available as an option.

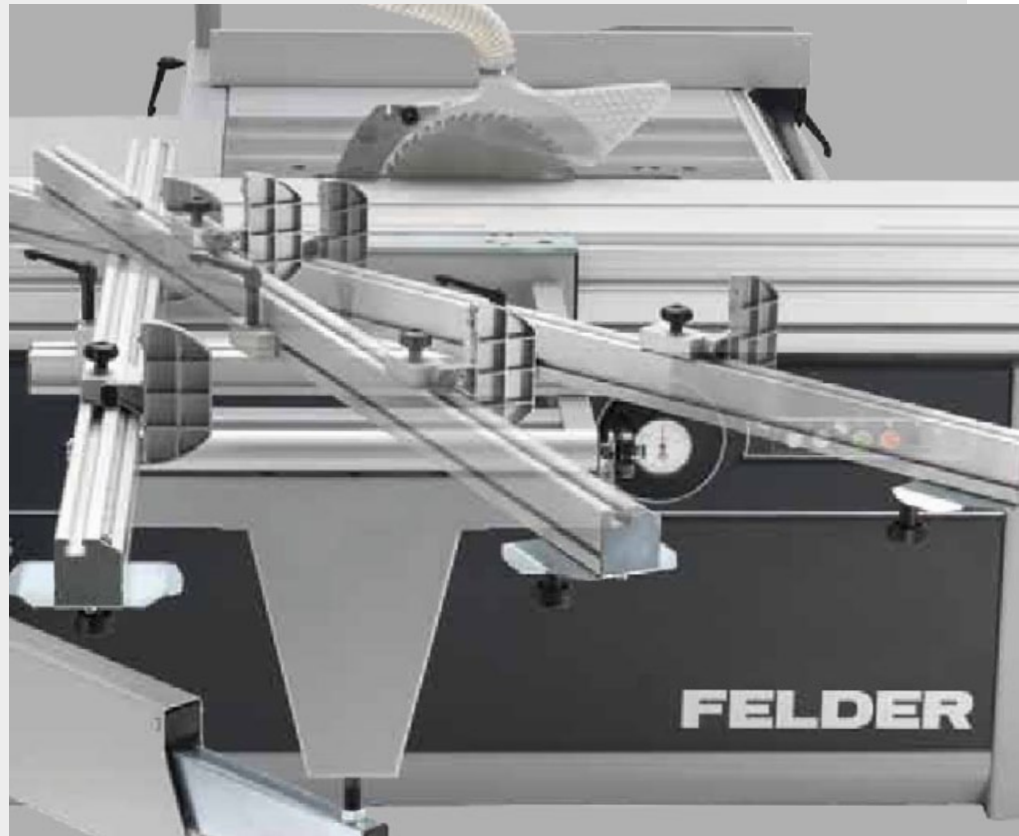

The large crosscut fence stops are constructed in such a way that a small tongue on the stop fits perfectly into a groove on the fence. This keeps the stop firmly in place for both straight and tight angle mitred cuts.



Optional: Digital crosscut fence stops with settings to an accuracy to a tenth of a millimetre.



The bevelled mitre scale with accurate readout is visible from the operating area, enabling setting of the required crosscut value.



Your Felder, as individual as you!

## Precision mitre index system

### Pinpoint mitre settings

only by  
**FELDER**

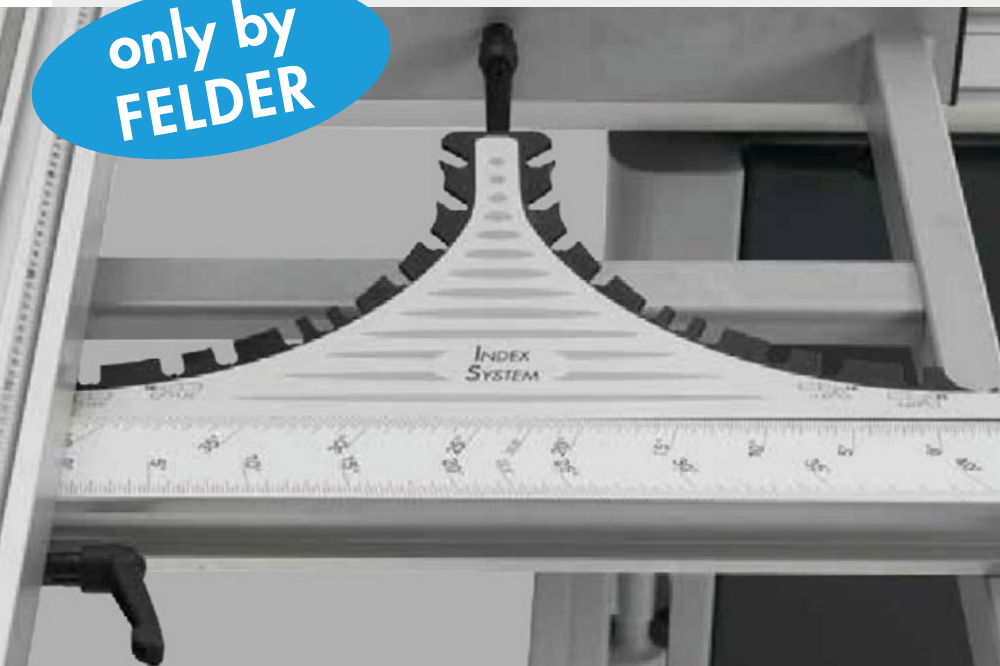

#### Accurate angle adjustment with the mitre index system including fence length compensation

(Optional for 1300 and 1500 outriggers)  
No reading errors due to scales and Nonius. No lost time with painstaking cautious attempts at setting the angle value. Hundred percent accurate adjustment and setting without lost time and reading errors, these are the advantages of the precision mitre guide index system. Highly precise index points enable the exact production of polygons as well as e.g. 5.625° (32 sides), 11.25° (16 sides), 22.5° (8 sides). Additional index points at 15°, 20°, 25°, 30°, 35°, 40° and 45° can be used when the crosscut fence is both at the front and at the back of the outrigger. Every index position is provided with length compensation. The highly precise Felder mitre index system is adjusted at the factory and every index position can also be individually fine adjusted. The index system integrates itself well into the machine design and will increase your productivity for an amazingly low investment amount.

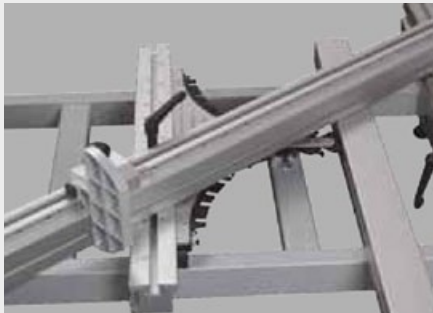

#### Precision mitre guide on the outrigger table

The precision mitre index system on the outrigger table allows you to freely select preset positioning stops at increments of 5°, and also at 22.5°. Using the index locating pin on the telescopic fence you can position it any position from +45° to -45°.



Your Felder, as individual as you!

#### Machine equipment options

	K 500	K 500 Professional	K 500 S	K 540 S	K 700	K 700 Professional	K 700 S	K 740	K 740 Professional	K 740 S	K 940 S
Precision mitre index system	<input type="radio"/>	<input type="radio"/>	<input type="radio"/>	<input type="radio"/>	<input type="radio"/>	<input type="radio"/>	<input type="radio"/>	<input type="radio"/>	<input type="radio"/>	<input type="radio"/>	<input type="radio"/>
Precision mitre guide with cutting length compensation for 1300/1500 outrigger	-	-	-	-	<input type="radio"/>	<input type="radio"/>	<input type="radio"/>	<input type="radio"/>	<input type="radio"/>	<input type="radio"/>	<input type="radio"/>

O ... Option - ... Not available

## Rip fence running along a chrome-plated round guiding bar

Rip cuts of the highest quality



### Rip fence

A rip capacity of 800 mm is standard with the option of 1250 mm. The rip scale is easy to read and perfectly integrated into the machine table.



When processing narrow workpieces with the saw blade at an angle, the rip fence can be placed face down to improve operator comfort.

The rip fence is easily and smooth to adjust, with a single hand clamping mechanism. The optional fine adjustment makes precise measurements possible.

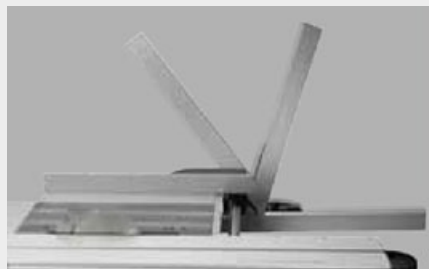

# Panel Saws



## Optional: Rip fence with electronic digital display

Perfectly integrated into the rip fence, the electrical digital display shows the rip setting accurate to a tenth of a millimetre. The display can be rotated through 90° depending on the working position. Additional functions such as the setting for incremental cuts also help to make day to day work easier.



The aluminium rip fence can be pushed further back to improve user comfort and safety when making repeat offcuts.

## Automatic rip fence

The electric motor positioned rip fence running on a maintenance free lineal guiding system with ball bearing bushings, moves quickly and accurately to within a tenth of a millimetre of the required cutting width. The rip fence can be tilted away at any point along the full rip length and guarantees perfect cuts with a maximum width of 1250 mm.



## The FELDER control panel - intuitive and clear

The operating panel provides you with all of the information relating to the rip fence in real time. You can enter the required value quickly and easily into the operating panel, saving time and increasing your productivity.



Your Felder, as individual as you!



# The Panel Saws



		K 500	K 500 Professional	K 500 S	K 540 S
Cutting height		102 mm	102 mm	104 mm	140 mm
Saw blade tilt		90°-45°	90°-45°	90°-45°	90°-45°
Rip capacity		800/1,250 mm	800/1,250 mm	800/1,250 mm	800/1,250 mm
4.0 HP (3.0 kW)		S	S	-	-
5.5 HP (4.0 kW)		O	O	S	-
7.5 HP (5.5 kW)		-	-	O	S
10.0 HP (7.35 kW)		-	-	-	-
Working height		890 mm	890 mm	890 mm	890 mm
	1,300 mm*	2,825 mm	-	-	
	1,550 mm*	3,325 mm	-	-	
	2,050 mm*	4,660 mm	4,660 mm	-	
	2,500 mm*	5,280 mm	5,280 mm	5,380 mm	5,380 mm
	2,800 mm*	-	-	5,980 mm	5,980 mm
	3,200 mm*	-	-	6,780 mm	6,780 mm
	3,700 mm*	-	-	-	-
B <sub>1</sub>		1,063/1,498 mm	1,063/1,498 mm	1,850/1,450 mm	1,850/1,450 mm
B <sub>2</sub>		1,300-2,000 mm	1,730-2,624 mm	1,730-2,624 mm	1,730-2,624 mm
Extraction connection-Ø saw/saw guard (overhead)		120/50 mm	120/50 mm	120/50 (80) mm	120/50 (80) mm

\*Cutting length with outrigger table with maximum cutting height, \*\*Details of the maximum travelling distance based on the length of the sliding table:  
S ... Standard configuration O ... Option - ... not available

## Space requirement

Scale

1:50

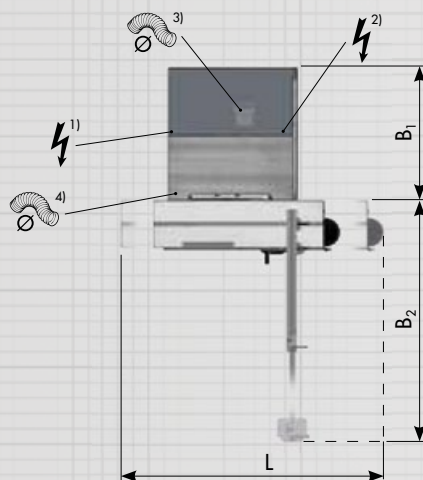

Symbolic image K 500, K 700, K 740

<sup>1)</sup> Power connection K 700, K 740<sup>2)</sup> Power connection K 500<sup>3)</sup> Extraction connection K 700, K 740<sup>4)</sup> Extraction connection K 500



K 700	K 700 Professional	K 700 S	K 740	K 740 Professional	K 740 S	K 940 S
104 mm	104 mm	104 mm	140 mm	140 mm	140 mm	133 mm
90°-45°	90°-45°	90°-45°	90°-45°	90°-45°	90°-45°	90°-45°
800/1,250 mm	800/1,250 mm	800/1,250 mm	800/1,250 mm	800/1,250 mm	800/1,250 mm	800/1,250 mm
S	S	-	-	-	-	-
○	○	S	-	-	-	S
○	○	○	S	S	S	○
○	○	○	○	○	○	○
890 mm	890 mm	890 mm	890 mm	890 mm	890 mm	890 mm
2,997 mm	-	-	2,997 mm	-	-	-
3,490 mm	-	-	3,490 mm	-	-	-
4,361 mm	4,361 mm	-	4,361 mm	4,361 mm	-	4,358 mm
5,280 mm	5,280 mm	5,473 mm	5,280 mm	5,280 mm	5,473 mm	5,278 mm
-	-	6,017 mm	-	-	6,017 mm	5,858 mm
-	-	6,817 mm	-	-	6,817 mm	6,658 mm
-	-	7,867 mm	-	-	7,867 mm	7,708 mm
1,058/1,493 mm	1,058/1,493 mm	1,058/1,493 mm	1,058/1,493 mm	1,058/1,493 mm	1,058/1,493 mm	1,074/1,509 mm
1,100-2,000 mm	1,872-2,636 mm	1,872-2,636 mm	1,100-2,000 mm	1,872-2,636 mm	1,872-2,636 mm	1,872-2,636 mm
120/50 (80) mm	120/50 (80) mm	120/50 (80) mm	120/50 (80) mm	120/50 (80) mm	120/50 (80) mm	120/80 mm



Further information about the technical data, individual configuration options and all noise level values can be found on the internet at [www.felder.at](http://www.felder.at)

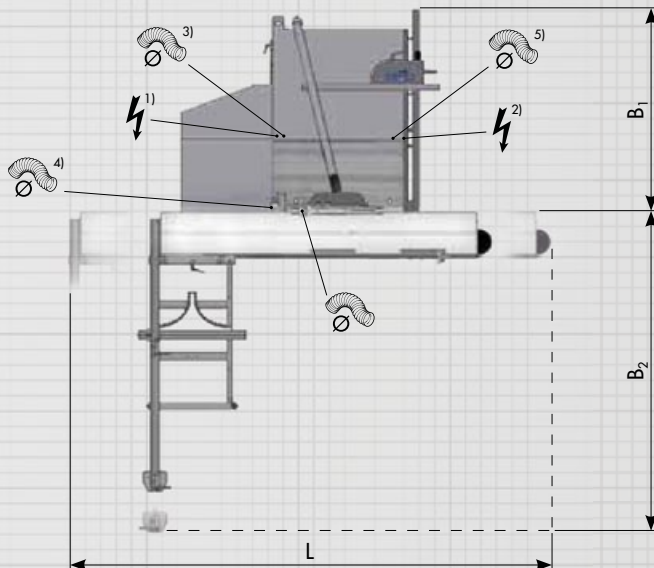

Symbolic image K 500 P, K 500 S, K 540 S, K 700 P, K 700 S, K 740 P, K 740 S, K 940 S  
<sup>1)</sup> Power connection K 500 P, K 700 P, K 700 S, K 740 P, K 740 S  
<sup>2)</sup> Power connection K 500 S, K 540 S, K 940 S  
<sup>3)</sup> Extraction connection K 500 P, K 940 S  
<sup>4)</sup> Extraction connection K 540 S  
<sup>5)</sup> Extraction connection K 500 S, K 700 P, K 700 S, K 740 P, K 740 S

Dimensions given can vary if special equipment is used